

U-Boat binoculars

Introduction

I. A few words about history of submarines

II. The First World War

III. The Second World War

IV. Submarines and binoculars used on vessels

1. German submarines

The binocular 7 x 50 used on the German U-boats

The binoculars 8 x 60 used on German U-Boats

Large binoculars mounted on the deck;

2. Japan submarine

The 7 x 50 binocular were used on the Japanese submarines

Large binoculars mounted on the deck

“N-K OPTICAL ORDNANCE” by Richard Lane

3. Italian submarine

The binoculars; 7 x 50 or 7 x 56 were used on the Italian submarines

4. US submarine

The binocular 7 x 50 were used on the U.S. submarines

Large US binocular mounted on the deck

5. French submarine

6. British submarine

The binocular 7 x 50 were used on the British submarines

CF41 7 x 50 binoculars by Frank Lagorio

V. U-boat glasses produced only to be used to U-Boats

1. External features of the binoculars

2. Internal features of the binoculars – optic system

3. Swedish version of the U-boats binoculars

VI. Varieties of U-Boat glasses produced in other countries

1. The Canadian binocular by Frank Lagorio

2. The Russian binocular

VII. Appendix

Bibliography

Introduction

This article was written with the participation of many binoculars enthusiasts.

The U-Boat glasses are very specific binoculars. They have a special construction, due to the location of their use.

Presenting the U-Boat binoculars we have to say a few words about submarines.

I. A few words about history of submarines

The first historical note about a vessel which made a journey of 9 miles under the water was in the fifth century BC:

'The historian Herodotus told of a Greek diver named Scyllias, who "plunge into the sea at Aphetes, and did not come to the surface until Artemesium" [...] "I can only suppose" Herodotus added, "that he made the journey in some sort of vessel" – quote from the book *The U-Boat's* by Douglas Botting.

Next in a medieval picture was shown and described that *Alexander the Great* was observing a panorama undersea, in a glass capsule. The capsule was moved up and down by rope. The air for breathing was sealed inside.

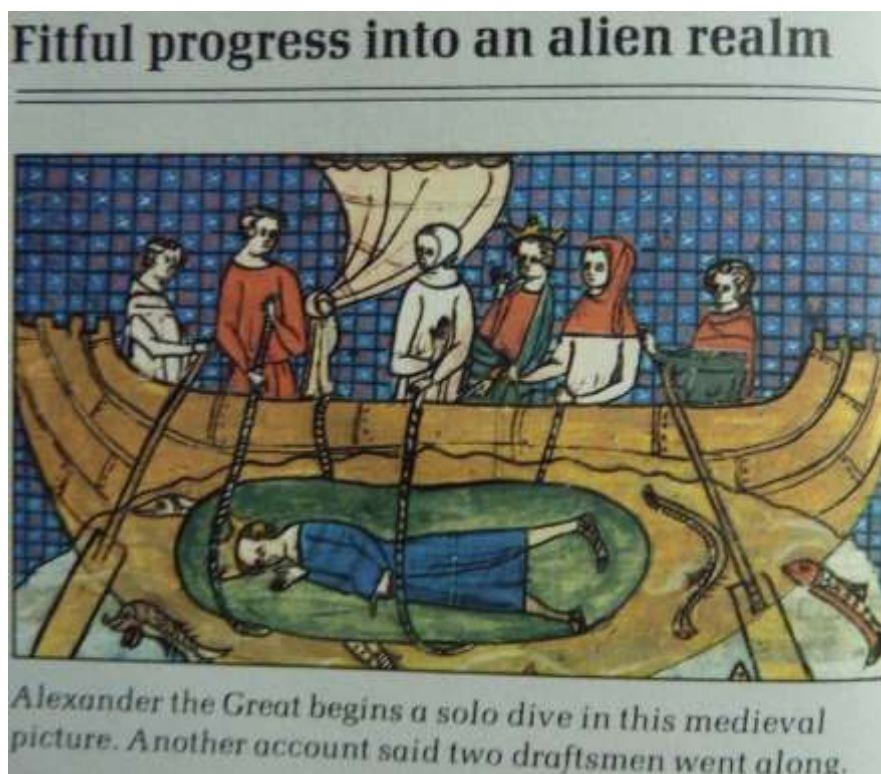

Pict 1; The picture from the book; *The U-Boat's* by Douglas Botting; page 16 – in our collection

In Fifteenth Century the thought of a submarine had been developed by Leonardo da Vinci. He observed the waves of the water under various conditions and his observation are noted in the drawings. Leonardo devised a project of a machine which could move under the water.

The problem with these kinds of ships was to provide the air to the vessel.

The real thought of travelling under the sea surface was born in 16th Century. The English scientist William Bourne said that it is possible to go under the water to the bottom and come back in a vessel with a flexible air chamber. William Bourne developed the Leonardo da Vinci idea.

In 2008 BBC 2, in the program “Building the Impossible” rebuilt a version of Bourne’s design, the Seventeenth Century submarine. We were watching that program. Our impression was that inside of that submarine conditions were extremely uncomfortable for a traveller.



Pict 2; The picture from the BBC site- program “Building the Impossible”

The Bourne’s thought was developed by two Americans: David Bushnell and Robert Fulton. They built a submarine named ‘Turtle’ and attempted to destroy a British war ship by attaching gunpowder and a timing device to the hull, in 1776. The *Turtle* was a paddle propeller blade.

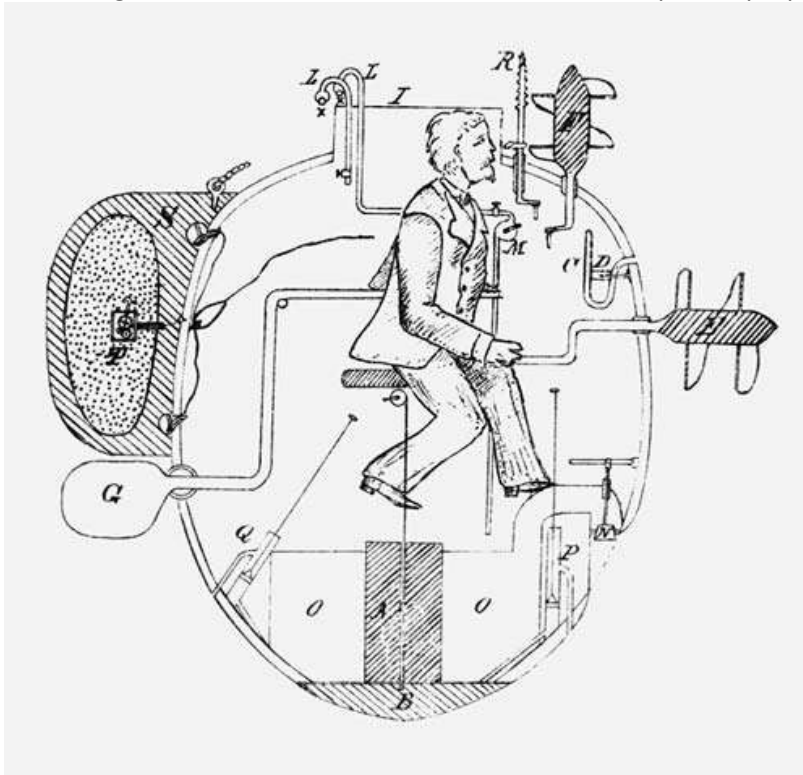

Pict 3; The picture from National Museum of American History
<http://americanhistory.si.edu/subs/history/subsbeforenuc/early/turtle.html>



Pict 4; The Turtle model at The Royal Navy submarine museum

Then attention on the subject of submarine was neglected for a time. It seems that the French writer Jules Verne, in 1870, had built up the most relevant submarine science fiction vision of the vessel, named- 'Nautilus', in the book: *'Twenty Thousand Leagues Under the Sea'*.

The first submarine to be mass-produced was human-powered. It was the submarine of the Polish inventor Stefan Drzewiecki; 50 units were built in 1881 for the Russian government. In 1884 the same inventor built an electric-powered submarine.

At the beginning of Twentieth Century the development of submarines was huge.

Many countries had constructed the fleets of submarines; The USA, Germany, France, Italy, Canada, Norway, Japan

II. The First World War

Submarines played a massive impact in WWI.

Before the WWI Germany had 20 U-Boats (*Ubootwaffe* "U-boat force"), and Britain was equipped with 74 submarines. At the beginning of WWI, British ships were only to control the coast, while the German were to destroy the enemy ships and reduce their number of vessels.

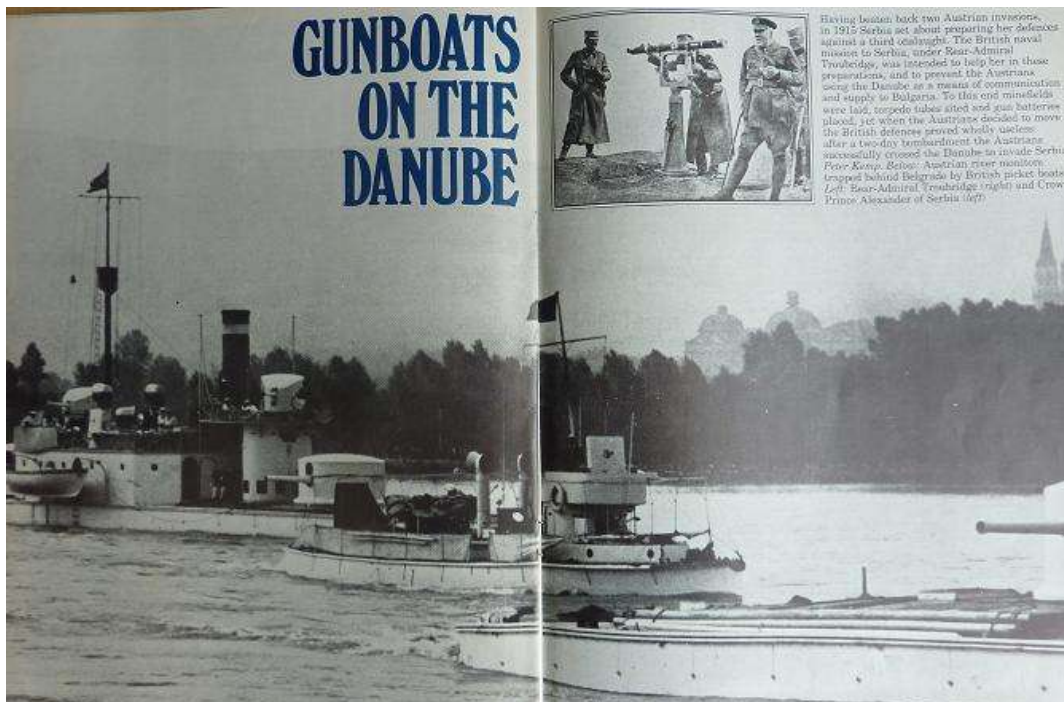

Pict 5; 'History of the First War World' Magazine No 39; published in 1970; page 1084; in our collection

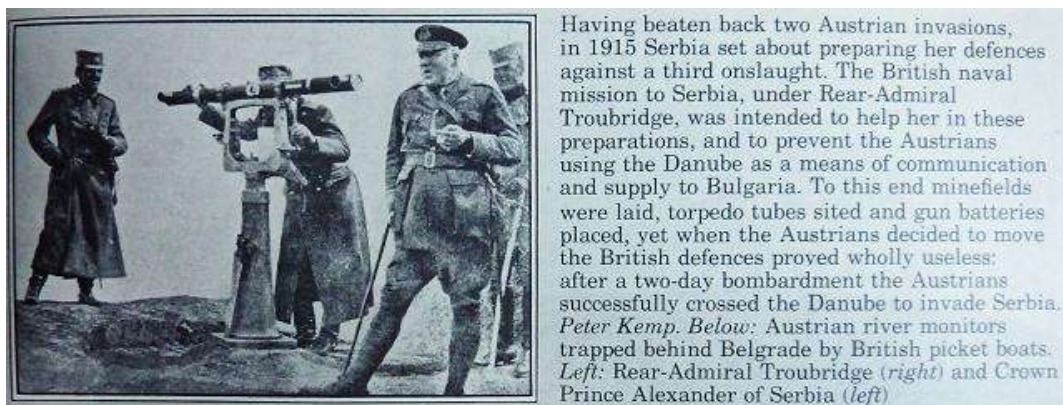

Pict 6; The description of the picture 1.

During the WWI Germany had built 345 new U-Boats and lost 178. The U-Boats had served 13,000 officers and sailors.

Italy was equipped in 47 submarines; France had 50 vessels at the beginning of WWI, 61 at the end. The US Navy fleet in 1914 was equipped into 29 submarines, in 1917 it was 42.

After the ceasefire that finished the war in November 1918, the allies would like to arrange a strong peace terms prevented Germany from dominating Europe again.

Under the treaty signed at Versailles, the Allies set up the terms for Germany. The army was to have no more than 100 000 men; its navy only six warships above 10 000 tonnes; and no submarines.

However, Nazi Germany began again to rebuild their Navy forces during 1930s.

III. The Second World War

Nevertheless, at the beginning of WWII, in 1939 the German Kriegsmarine had in their service 57 U-Boats.

Between 1940 and the end of the war the German Kriegsmarine was equipped with 593 only U-Boat type VIIC – the most equipped with technical devices from earlier U-Boat versions. The type of U-

Boat with the special weapons system: four 533 mm torpedo tubes and carried 14 torpedo; a 37 mm gun on the forecastle and two twin 20 mm anti-aircraft guns. Those U-Boats had a two-shaft diesel/ electric power system. It gave the boats a surface speed 17 knots (31 km/h) and 8 knots (15 km/h) underwater. They could stay submerged for 18 hours and sailed at 4 knots (7, 5 km/h). Around the Europe were built shelters with dry or wet docks for the U-Boats;

- In France at the harbours - Bordeaux, Saint- Nazaire, La Pallice, Brest, Lorient;
The U-Boat bases on the French Atlantic coast were three types: non-tidal with a lock leading to the open sea; tidal faced onto the sea; and onshore where vessels were brought on dry land. German adapted facilities of former French Navy.



Pict 7; The map inserted into Magazine No 55 'After the Battle – U-Boat Bases'; in our collection

- in Germany - Hamburg, Bremen, Laboé near Kiel, Heligoland /Helgoland - Germ/; In Hamburg were two shelters, one of them very large for 15 U-Boats with 5 wet docks;
- Belgium - Bruges;
- South coast of Norway – Bergen, Trondheim.

Many of them did not survive the war. The larger of all in Bordeaux constructed in 1941-1943 survived. It was built; 245 m wide, 162 m long and 19 m high. The roof was 5, 6 m thick above the pens and 3, 6 m thick above servicing area. The shelter is today in private use, but it is possible for a visit with permission.

Other bases were built in the same construction.

In 1981 was made the German film 'Das Boot' based on a patrol in the Atlantic in 1941. In this short part, at the beginning of the film is visible a pen in a U-Boat shelter, you can see it at:

<http://www.youtube.com/watch?v=Nwc0shJ2aYc>

The German U-boat bases were in Asia as well; in Malaysia (during the war – Malaya) – under Japan occupation, at Kobe – Japan, and at Singapore.

In 1936 Germany signed treaties with Japan and Italy. In 1940 was signed The Tripartite Pact between Germany, Japan and Italy.

Germany was in an economical cooperation with Japan as well, they exchange raw materials. Japan was receiving from Germany optical glasses, among other items.

IV. Submarines and binoculars used on vessels

The short history of submarines of many countries involved in WWII, concerns a question; what varieties of the binoculars were used on those vessels in each country.

Submarines were fitted with some optics; periscopes and many types of the observing binoculars.

In general way we can divide binoculars used on the submarines;

- Large binoculars mounted on the deck of the submarines;
- Handheld observing binoculars.

A range of handheld binoculars were used in the fleet. The most seen in the war time pictures from all countries are **7 x 50**; and **8x60**.

7 x 50 binoculars were frequently used on the submarines, during the WWII, because on a small ship the higher magnification of the binocular it is much more difficult to use in rough weather.

Furthermore, John Gould British scientist and researcher in the publication 'Binoculars for Surveillance Use' pointed:

"It has long since been known that 7 x 50s [...], and other binoculars of similar specification, with a large depth of focus, that very little focusing adjustment is really needed, either for distance or individuals. Hence it is quite possible and very desirable for both sealing and cost, to preset such binoculars to a standard focus to suit the majority of likely users."

The 7 x 50 models used on the submarines handle ability were high:

- They fitted naturally into the hands of the sailors as often they had worn gloves;
- They were well balanced;
- And weight and size were not awkward to carry.

It has to be emphasizing that not all models of binoculars could be used to submarines.

The models used to vessels had to be constructed in a special way. They should be; waterproof or watertight.

- **Waterproof** – does mean that the binocular is resistant to the water, but not watertight. The prisms boxes are not sealed nor the object glasses. The construction prevented against damp.
- **Watertight** – means that the binocular can be fully immersed under the water to a limited depth before water will penetrate inside. These binoculars were fitted with watertight glands on all moving joints.

John Gould says: "Any binocular designed for use at sea, or in damp dusty or humid conditions should be filled with clean dry air or an inert gas, and then sealed [with waxes]"

Basically not all models produced during WWII were filled with gas. We have not seen any war time binoculars where gas was present.

1. German submarines

The binocular 7 x 50 used on the German U-boats



Pict 8; On the U-552; on the conning tower; 7 x 50 Zeiss smooth eyepiece barrel and 7 x 50 Zeiss rubber armored

At the moment we can specify the models used on the German U-boats:

- 7 x 50 Leitz



Pict 9; Beh (Leitz) 7x50 No320169 in our collection; Copyrights pictures Anna Vacani

This 'beh' model is fitted with coated lenses with Porro II optic system. The body built up from an alloy. It is very light binocular – 1185 gram (2.61 pounds).



Pict 9a; 7 x 50 beh & Arriflex camera; Picture from "U-Boats in the Atlantic; World War 2 Photo Album No 11" by Paul Beaver; in our collection

- *7 x 50 beh armored*



Pict 10; 7 X 50 beh (Leitz) No474230 (late model) in our collection; Copyrights pictures Anna Vacani

This model is fitted with desiccator cartridges. The binocular is with Porro II prisms system. This model was built for marine use – on the surface vessels and on U-Boats as well. It is well armored with thick rubber.

(Look German binoculars, page 2)

- *7 x 50 blc* (all our 7x50 blc -> German binoculars, page 3)



Pict 11; 7 X 50 blc No 60438; Binoctar type, with letter 'U' under the hinge screw, in our collection; Copyrights pictures Anna Vacani



Pict 12; 7 x 50 blc Binoctar type with rubber fluted armored; Picture from "U-Boats in the Atlantic; World War 2 Photo Album No 11" by Paul Beaver; in our collection.



Pict 13; 7 X 50 blc – smooth barrel; No 38017 in our collection; Copyrights pictures Anna Vacani

This model has extra sealing on eyepiece focusing mechanism. On the Benutzer cup is information about focusing adjustment.



Pict 14; 7 x 50 blc with improvised sunshields; Picture from "U-Boats in the Atlantic; World War 2 Photo Album No 11" by Paul Beaver; in our collection

The sunshields (rain guard) pictured above have not been factory made. This model often is seen in photographs with rubber fluted armored on the top and body of the binocular, and rubber objectives protectors.



Pict 15; 7 x 50 blc with rubber fluted armored; picture from 'U-Boot-Fahrer '(U-Boat Sailors) by Lothar-Günther Buchheim; published by Piper 2001; ISBN 3-492-04044-6; page 107;The picture kindly found by James Stewart.

- 7 x 50 Fixed focus model



Pict 16; 7 x 50 Carl Zeiss Jena; No production 38139 from Dr Stephen Rohan collection; Pictures taken by Dr Stephen Rohan; Copyrights Dr Stephen Rohan

This model is with Porro I prism system. The lenses are coated. The body has desiccator cartridges in the objective end of the prism housing. This binocular is exceptional as it has fully fixed focus eyepieces. These features of the binocular are suitable for use the binocular in U-Boats.

- **7 x 50 blc H model** (look "Unusual Optics" page 2)



Pict 17; 7 X 50H blc in our collection; Copyrights pictures Anna Vacani

This model is seen on U-Boats not so often. Later 'H' prism system was discontinued. It was built with coated optics. The production 'H' prism system was rather expensive and time consuming to manufacture.

The binoculars 8 x 60 used on German U-Boats

- **8 x 60 H Carl Zeiss Jena first model**

The first model of the D.F. 8 x 60 H was used on German U-boats.



Pict 18; DF 8 x 60H Carl Zeiss Jena, production No 1677267, in our collection; Copyrights pictures Anna Vacani

This model was built in September 1935. It was factory fully internally coated. The first coating did not cover all objective surfaces, there were missing areas at the peripheral edge. There was a ring around very edge. Since 1940 the internal surface was coated on the objectives.



Pict 19; DF 8 x 60H Carl Zeiss Jena with uncoated area; Copyrights pictures Anna Vacani

It is fitted with Porro II optic system and 'H' structure to increase light transmission. The eye lenses are 22 mm diameter. They are not the same as the later model 8 x 60. Later models had bigger eye lenses.



Pict 20; DF 8 x 60H Carl Zeiss Jena eye lenses; Copyrights pictures Anna Vacani

The eye lenses were constructed in a special way. It is a gap between eye lens and the lens's tube. These spaces were provided to set up filters.

This 8 x 60 model has a vertical line reticule fitted in right hand ocular like next 8 x 60 models. The production number is engraved on the washer. If the washer is lost, it is not possible to find out the production number of a binocular.

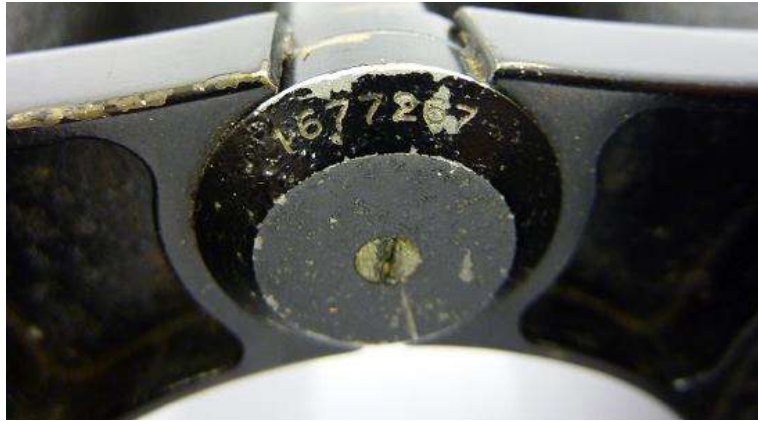

Pict 21; DF 8 x 60H Carl Zeiss Jena; washer with production number; Copyrights pictures Anna Vacani

This model was the first of all WWII German Zeiss 8 x 60 hand held binoculars.

- 8 x 60 blc

This model was produced after the 'H' model from late 1940. The optic is fully coated. This binocular lenses contain an aspheric elements (see article '25 x 100 binoculars').



Pict 22; 8 x 60blc, production No 2084791; 1941 in our collection; Copyrights pictures Anna Vacani

The binocular was built for Kriegsmarine use on ships and u-boats. It is fitted with desiccator cartridges and vertical line reticule.



Pict 23; 8 x 60blc, production No 2084791; with desiccator cartridges; Copyrights pictures Anna Vacani

The rubber eyecups are detachable. The tripod adapter can be used and fitted on the bending bar (see chapter V). The binocular users are astonished with the image quality of this glass. This binocular belonged to Terry's father Arthur Vacani.

- 8 x 60 beh porro I



Pict 24; 8 x 60 beh porro I – Commander Hans-Günther Kuhlmann on the bridge of U-166; Picture from web site: <http://www.pastfoundation.org/U166/U-166.htm>

The 8 x 60 beh Kriegsmarine model was seen on the documentary films and war time pictures, as well.

The lenses are coated. According to specialists opinion the model gives much better optical performance than later beh 8 x 60 Porro II model.

It is an early version with Porro I optical system; production time 1941-1942.

The basic model continued to be produced after the war in 1950s to 1960s. We do not have this model in our collection.

- **8 x 60 beh porro II rubber armored**

This model visually is similar to 7 x 50 beh. It is fitted with Porro II optical system. The desiccator cartridges are built in as in the model 7 x 50 – in the prism housing body.



Pict 25 ; 8 x 60 beh; No production 430696 from Dr Stephen Rohan collection; Pictures taken by Dr Stephen Rohan; Copyrights Dr Stephen Rohan



Pict 26 ; 7 x 50 and 8 x 60 beh from Dr Stephen Rohan collection; Pictures taken by Dr Stephen Rohan; Copyrights Dr Stephen Rohan

The binocular integrates tele –objectives and six element eyepieces.

According to opinion of binoculars enthusiasts, the glass does not have sparkling optical performance as Zeiss model 8 x 60.
It must to be mention that all binoculars used on German U-Boats were fitted with coated glasses.

In the German Film “Das Boot”, mentioned at the beginning of the article, was presented the binocular 8 x 60 blc, and used by the U-boat Commander. This model is the very early version of 8 x 60 blc - 1940.

The binocular was bought by Dr Hans Seeger and it is in Dr Hans Seeger collection. Here is the picture, kindly send by Dr Hans Seeger;



Pict 27; The binocular used in “Das Boot” film; The pictures were taken by Dr Hans Seeger; Copyrights Dr Hans Seeger

[Large binoculars mounted on the deck:](#)

On the German U-boats deck was mounted a pedestal mount with a clamping device, in the center for a large heavy binocular. This was the base for UZO (U-Boot-Zieloptik = U-Boat aiming optic) torpedo aiming device.

Researches of the war time films and the published books and magazines, often show these models; 8 x 60 and U.D.F.:



Pict 28; UDF 7 x50 blc Prod No 317903 in our collection

7 x 50 UDF was watertight to about 100 meters of diving; over this depth the glasses would be damaged. Usually the binocular was not left on deck when the U-boat was submerged; only in an emergency dive it was left on deck.

Read more in our article: "U.D.F. 7 x 50 blc U-boat sight" (Binoculars -> articles).



Pict 29; 7x50 U.D.F. and UZO; The 7 x 50 UDF binocular is described in the article "U.D.F. 7 x 50 blc U-boat sight".

[2. Japan submarine](#)

Japan heavily invested into its navy for decades, as it is the main means of transport of all natural resources.

In 1941 Japanese Navy was equipped into:

- 10 battleships – the largest in history – Yamato with heavy armament and seven aircraft carried (256 length) ;
- 38 cruisers;
- 112 destroyers;
- 65 submarines (111 was built during the war).
- Ca. 300 Ko-hyoteki (**Kaiten**); human –steer torpedo (sent on suicide missions) – Japanese midget submarines; built since 1941. They were launched from ‘mother ship’.

After 1941, Japanese industry had built 200 submarines. Industrial production was directed by the government only.

At the end of the war, the Japanese Navy conducted experiments on super-submarine; ten times longer. It was able to carry on 3 bombers and 140 mm guns and torpedoes under the water. At 30 December 1944 the first super- submarine *I-400* was launched (sunk 4 June 1946). The Japanese Navy further produced two vessels with 2 bombers, on board. All of them were destroyed by US,

preventing to be explored by Russian, this very secret and advanced submarine construction. The documentary film was made of the sinking of the *I-403*. We can see those experiments on these four parts of film produced by *Windfall Films and Spy Pond* with Association with National Geographic Channel:

<http://www.youtube.com/watch?v=fgfZPjHNCM&feature=endscreen&NR=1>



Pict 30; Japan submarine – I-400; December 1944 – 1945

The 7 x 50 binocular were used on the Japanese submarines as well



Pict 31; 7 x50 Japanese from Richard Lane collection; Picture taken by R. Lane; Copyrights R. Lane

[Large binoculars mounted on the deck:](#)

Thanks to Richard Lane, a collector and enthusiast of Japanese binoculars, we can learn what kinds of binoculars were used on the deck of Japanese submarine.

Richard lane has sent the article, which he has published in the *Nikon Journal at March 1994*. The article is republishing with the consent of the editor and publisher of the *Nikon Journal*.

Here's a link to the Nikon Historical Society:

<http://www.nikonhistoricalsociety.com/>

The part of the article by Richard Lane relating to the deck mounted binocular 20 x 120 on the Japanese submarine.

[N-K OPTICAL ORDNANCE - By Richard Lane](#)

PART IV

At the end of World War II the surviving submarines of the Imperial Japanese Navy were idle. Two dozen submarines in sweepers cove at Sasebo and twenty six were anchored at Kure were all that remained of the force. One hundred and thirty one other submarines never returned to Japan. What about the optical equipment used on these submarines? What company supplied the periscopes and binoculars to the elite submarine force? It should be no surprise to our group of Nikon collectors to find out that Nippon Kogaku made the Type 97 submarine binoculars that are featured in this article!

The date plate indicates a manufacture date of October 1944. Their serial number is 311 and this example was probably made toward the end of the Type 97's production run. They weigh in at 170 pounds, due in part to their quarter inch thick casing! The 120mm front objectives are recessed and protected by 13mm thick flat front glass plates which measure 135mm across! Twelve screws and water-proof seals on the front protect the internal optical elements. Further, a heavy objective shield swings down to protect the front glass. The rear of the binoculars features a rotating wheel which, when loosened, allows the waterproof hatch to swing upward to reveal the eyepieces. A rotating interocular scale can be used to adjust the distance between the eyepieces for varying eye widths. A rubber seal surrounds the open hatch at the rear. On top there is a circular cap which is secured with twelve screws and a rubber seal. Below that is a pint size container that contains silica gel.

From this design it is apparent that these binoculars retained deck mounted at all times and had to withstand pressures encountered on deep diving (300ft for a typical I-boat). In addition, they had to handle depth charge attacks and the optical elements had to remain collimated and ready for use when the submarine surfaced. The alternative to the waterproof glasses would be to dismount a large conventional 20x120 binocular. This would have been cumbersome during an emergency dive. Emergency dive times for Japanese submarines were typically under 90 seconds.

[...]

In away the Type97 binoculars tell their own tale of the Pacific War. Although unique to the Japanese submarine force, the 120mm binoculars did not prove to be a distinct advantage toward the end of the war. In the book, "I-Boat Captain", Zenji Orita describes his plea for radar to the 6th fleet headquarters in January 1944. Part of the passage reads, "Third, our chief weapon for detecting the enemy at present is 120mm binoculars. Top priority must be given to equipping submarines with radar and electronic counter-measure devices." As it turned out, not even the best designed binoculars from Nippon Kogaku could outperform radar!



TAKE A LOOK AT THIS MONSTER! WEIGHING IN OVER 170 POUND, THESE 120MM GLASSES ARE ENCASED IN A HEAVY STEEL PROTECTIVE HOUSING. THEY HAVE BEEN MADE WATER TIGHT BY THE USE OF HEAVY WELDS, 13MM THICK COVER GLASSES, HEAVY STEEL, COVER DOORS FRONT AND REAR, AND THE USE OF WATERTIGHT SEALS AND 'O' RINGS. THE REAR COVES PLATE IS LOOSENED WITH A WHEEL SIMILAR TO THAT USED ON THE WERTIGHT DOORS FOUND ON THE SUBMARINES THEMSELFS! R. LAKE



NIKON HISTORICAL SOCIETY JOURNAL



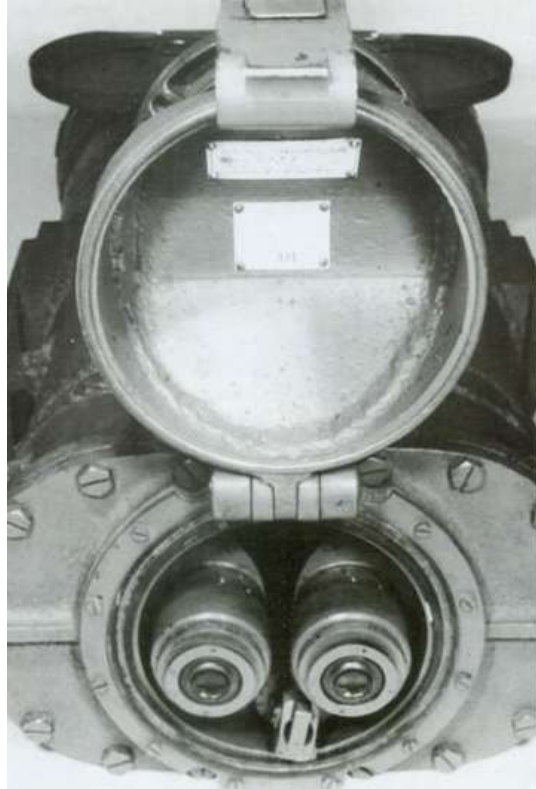

A CLOSER VIEW OF TO REAR WATERTIGHT HATCH WICH IS CONTROLLED BY A LOCKING WHEEL. THE EYEPIECES CAN BE ADJUSTED FOR EYE SEPARATION. ON THE INSIDE SURFACE OF THIS HATCH IS THE IDENTIFICATION PLATE. IT SHOWS A PRODUCTION DATE OF OCTCBER 1944 WITH THE SERIAL NUMBER 311. ALSO PRESENT IS THE NIKKO LOGO USED BY NIPPON KOGAKU; BOTH BEFORE, DURING AND AFTER THE WAR. R. LINE



NIKON JOURNAL MARCH 31. 1994

In the US National Archives are some pictures taken on the ship of the Japanese submarine *I-400* after the surrender, the first super- submarine *I-400*, sunk 4 June 1946 by US. Today we present a few.



Pict 32; 20x120 type 97 on the tower; the picture from US National Archives, kindly sent by Richard Lane



Pict 33; 20x120 type 97 – the objectives; the picture from US National Archives, kindly sent by Richard Lane



Pict 34; 20x120 type 97; the picture from US National Archives, kindly sent by Richard Lane



Pict 35; 20x120 type 97; the picture from US National Archives, kindly sent by Richard Lane



Pict 36; 20x120 type 97 from Richard Lane collection; Picture taken by R. Lane; Copyrights R. Lane



*Pict 37; 20x120 type 97 from Richard Lane collection; Picture taken by R. Lane; Copyrights R. Lane
Richard Lane says: "The Type 97 binocular prisms are actually larger than a standard Japanese WWII 20x120 (several millimetres on each face)."*



Pict 38; 20 x 120 Japan, the pressure element in front of objective; the picture from Dr Hans Seeger book - Hans T. Seeger - Militrische Fernglser und Fernrohre in Heer, Luftwaffe und Marine; page 272; Photograph and description Kevin K. Kuhne

3. Italian submarines

In 1940 the Italian submarine fleet had 115 units. We can read the history of the Italian submarine during WWII on the <http://www.uboataces.com/articles-fareast-boats3.shtml> :

“At a Naval Conference on February 20 1943, Gross admiral Donitz, who was newly appointed Grand Admiral of the Kriegsmarine briefed Adolf Hitler about the unacceptably high losses of German surface ships transporting war materials to and from the Far East. During that conference, Donitz suggested that the large Italian submarines were unsuitable for warfare in the Atlantic and that they should be converted for transport duties to the Far East.”

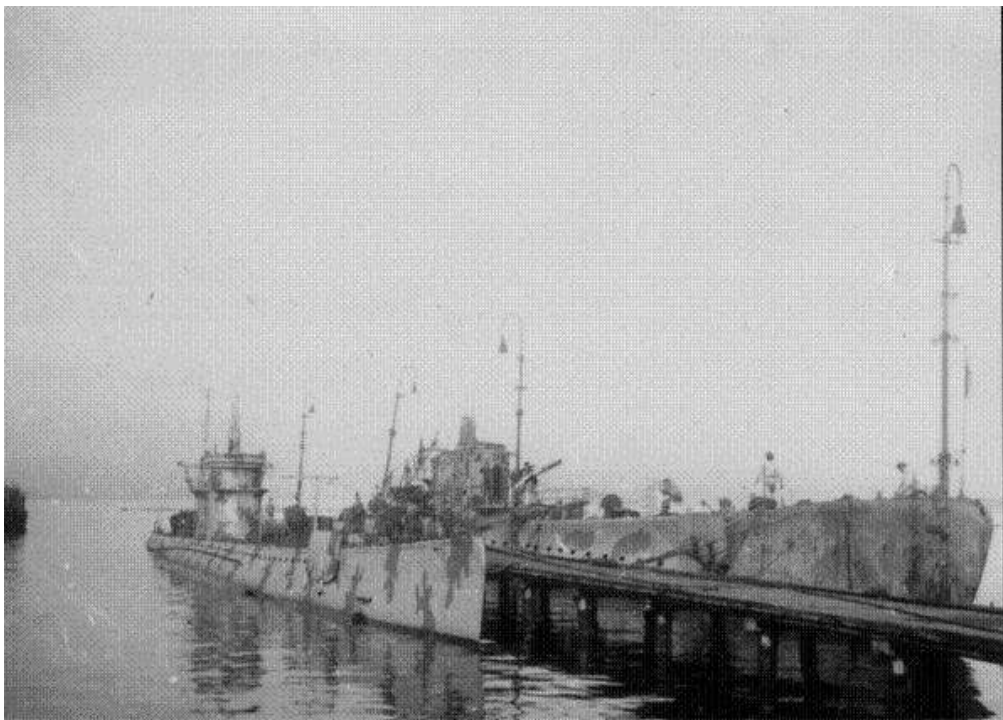

Pict 39; 'Ruggiero Settimo' Italian submarine; Picture was kindly found by Paolo Monti

The binoculars: 7 x 50 or 7 x 56 were used on the Italian submarines:



Pict 40; 7 x 50 or 7 x 56 Hensoldt binocular on use on 'Ruggiero Settimo' Italian submarine; Pictures was kindly found by Paolo Monti.

Hensoldt 7 x 56 is a very interesting model. During the war the factory made experiments with this model. All optic surfaces were multicoated; inside and outside of surfaces. However not every Hensoldt 7 x 56 was multicoated. A small percentage was multicoated.



Pict 41; 7 x 56 Hensoldt (bmj) multicoated; No 56279 from Dr Stephen Rohan collection; Picture taken by Dr Stephen Rohan; Copyrights Dr Stephen Rohan



Pict 42; 7 x 56 Hensoldt (bmj) multicoated; No 556279 from Dr Stephen Rohan collection; Picture taken by Dr Stephen Rohan; Copyrights Dr Stephen Rohan



Pict 43; 7 x 56 Hensoldt (bmj) multicoated objectives; No 556279 from Dr Stephen Rohan collection; Picture taken by Dr Stephen Rohan; Copyrights Dr Stephen Rohan



Pict 44; 7 x 50 Leitz binocular on the Italian submarine; Picture from "History of The Second World War" volume 4 No3 in our collection



Pict 45; 7 x 50 Zeiss binocular on the Italian submarine – 'Adua' class; Picture from "War Machine; Arm Forces of The World: US Army (Part 2) Science versus the U-Boat" No 62 page 1236; in our collection

4. US submarine

During WWII the United States Navy had 314 submarines in service (including 51 in Pacific area). The vessels conducted the war on many fronts; mainly against Japan after the Japanese attack on Pearl Harbour at 7 December 1941. In consequence of the attack admiral Harold Stark send the order; "**Execute unrestricted air and submarine warfare against Japan**". Since that date the USA became a part of the WWII.

The United State became the "arsenal of democracy" as President Roosevelt named the time of the WWII, and in period of 1941 – 1945 the US built 200 submarines, of which 195 was the *Gato/Balao* class (Named after the first vessel of this design, *USS Gato*) – 95 m long (312 ft) long, 8,3 m (27 ft) in the beam (width); 20 knots (37 km/h) on the surface and 9 knots (16,5 km/h) submerged and armed with 21 in (533 mm) torpedoes. During 1942 fitted with radar. The submarines haunted in small "wolf-packs" of three to five.

By the end of 1944 so many Japanese ships had been sunk by US submarines that targets were becoming tough to find. The major achievement was to cut Japan's supplies of raw materials and food imports.

The imported metal ran out in Japan and Japanese people were allowed only one metal cooking vessel and one bucket per household. They grew rice in their parks, pumpkins along their streets.

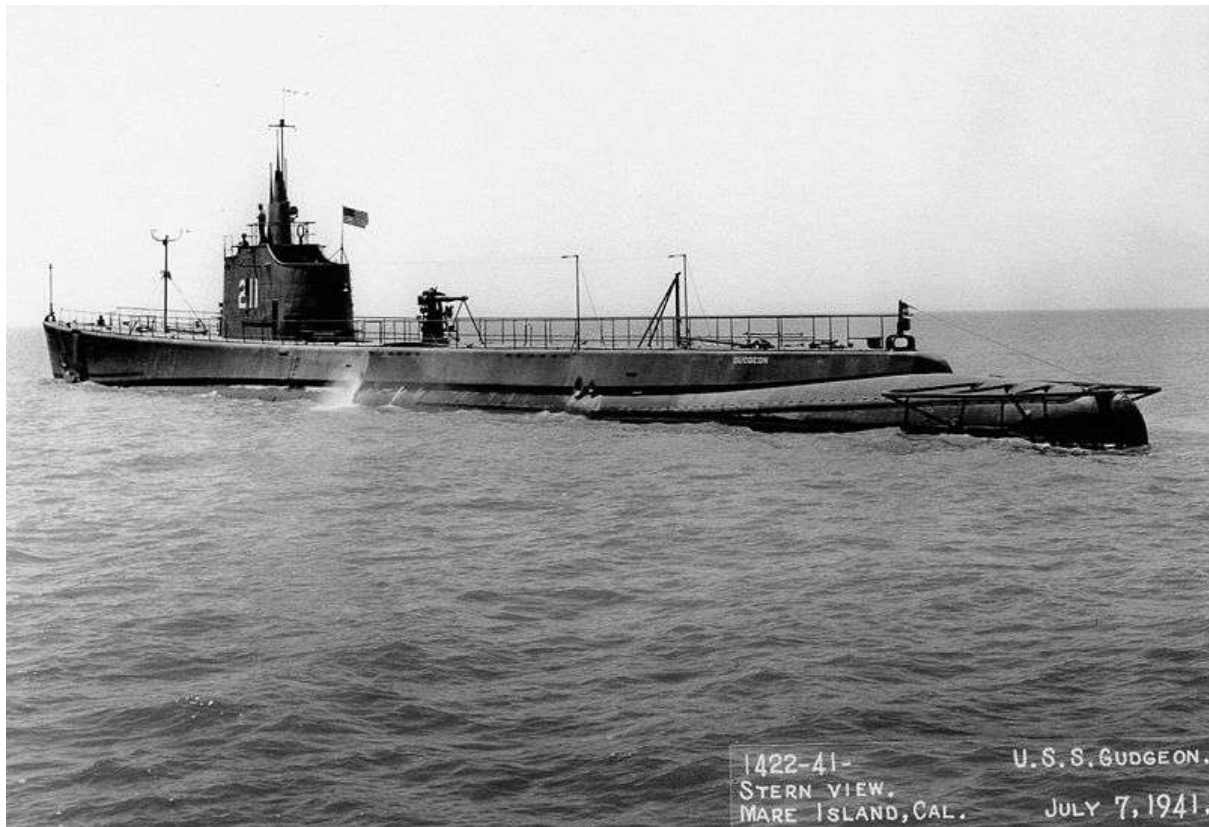

Pict 46; USS Gudgeon1941

The binocular 7 x 50 were used on the U.S. submarines:

7 x 50 U.S. Navy Buships Mark 45 Mod 0, Hayward Los Angeles Calif;

Dr Stephen Rohan says in his book: "Military Binoculars" the special uses of the binocular were: "underwater demolition units and submarine service personnel during WWII primarily use this model. It is waterproof. The MK 45 has a zerk fitting (in English grease nipple) in the hinge to apply lubrication to the hinge joint"



Pict 47; 7 x 50 U.S. Navy Buships Mark 45 Mod 0, Hayward Los Angeles Calif from Dr Stephen Rohan collection; Pictured by Dr S. Rohan; copyrights: Dr Stephen Rohan



Pict 48; 7 x 50 U.S. Navy Buships Mark 45 Mod 0, Hayward Los Angeles Calif from Dr Stephen Rohan collection; Pictured by Dr S. Rohan; copyrights: Dr Stephen Rohan

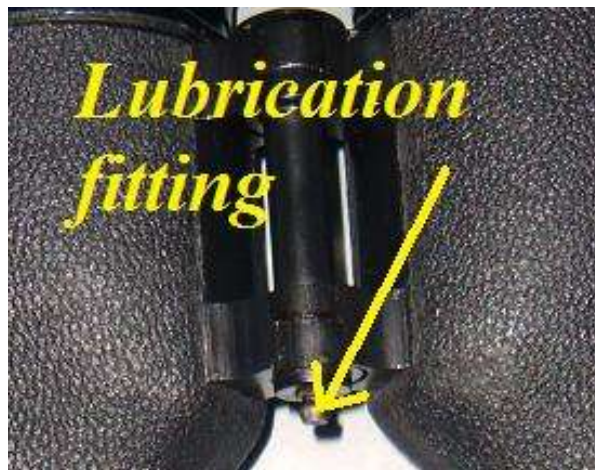

Pict 49; 7 x 50 U.S. Navy Buships Mark 45 Mod 0, Hayward Los Angeles Calif – lubrication part

The author pointed that binocular is radically different from other models.

“1)The body is drawn aluminum, whereas most of the other US binocular bodies are shaped from cast aluminum.

[...]

4)The prism clusters are suspended from the cover plate, whereas, in the other types of the binoculars, the prism cluster are mounted to a shelf, which rest on lugs cast into the binocular body.

5) Rubber gaskets are used on the seats of the eye lens and objective lens, also between the objective adapter and body; and the eyepiece lens is scaled with an “O” ring to keep moisture out of the body. Prior to this most sealing was done via sealing waxes and compounds and greases.”

Large US binocular mounted on the deck:

The binoculars US Busch & Lomb MK 91 and MK 93 models were mounted permanently on submarine conning tower bridges and to resist undersea pressure.

Some bases were very large, depending of the weight of the binocular and other attachments.

In the Museum at the New Naval Submarine Base New London Groton Connecticut is exposed the part of the Target Bearing Transmitter with the binocular Bausch & Lomb MK 91 Mod 0, on the top:



<http://www.usnautilus.org/virtualTour/mainexhibit.shtml>

The binocular could be mounting to the training tools as it is showed on the scheme:

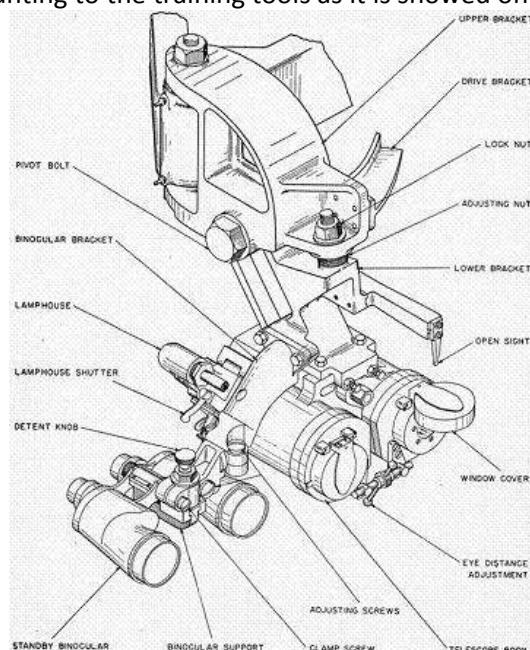

We have in our collection Bausch & Lomb MK 91 Mod 1, produced in 1946, serial number 1808. It is the 6 x 50 model. The MK 38 model has 6 x 42 magnifications.

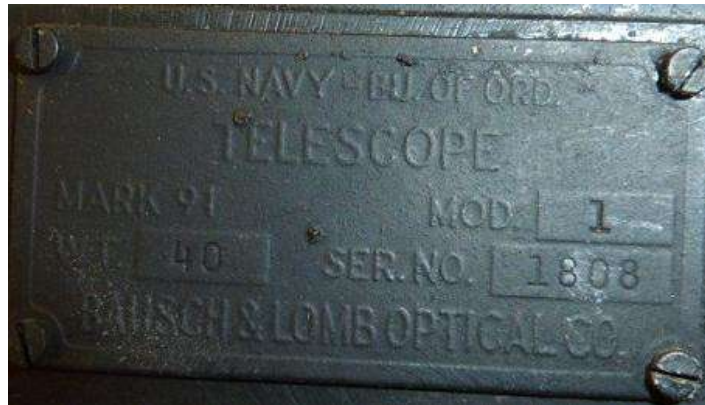

Pict 50; Bausch & Lomb MK 91 Mod 1; the plate; copyrights pictures Anna Vacani

The binocular is heavy - weight 40 lbs (18, 16 kg). The body is made from cast steel. The original production document has been supplied.



Pict 51; Bausch & Lomb MK 91 Mod 1; 6 x 50 in our collection; copyrights pictures Anna Vacani

The objectives have a unique feature; the filters are built into the covers.



Pict 52; Bausch & Lomb MK 91 Mod 1; the objectives covers and; the eye distance adjustment; copyrights pictures Anna Vacani

The binocular bodies are watertight.
Additional exceptional element is a watertight lamp house mounted on the body.

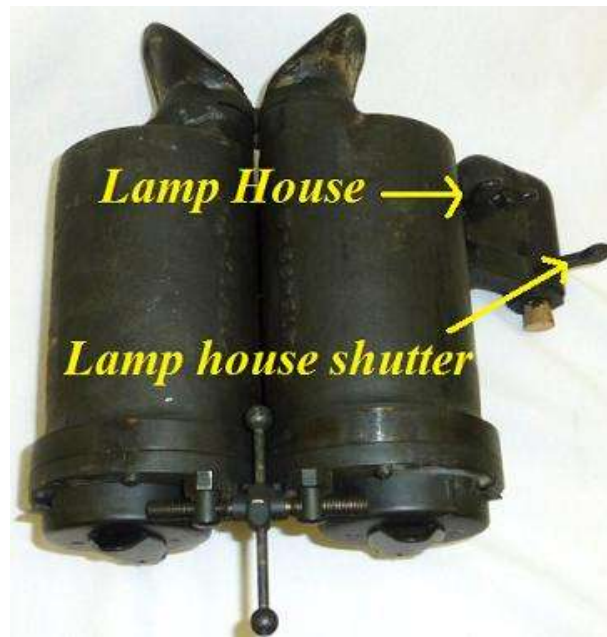

Pict 53; Bausch & Lomb MK 91 Mod 1; the lamp house; copyrights pictures Anna Vacani

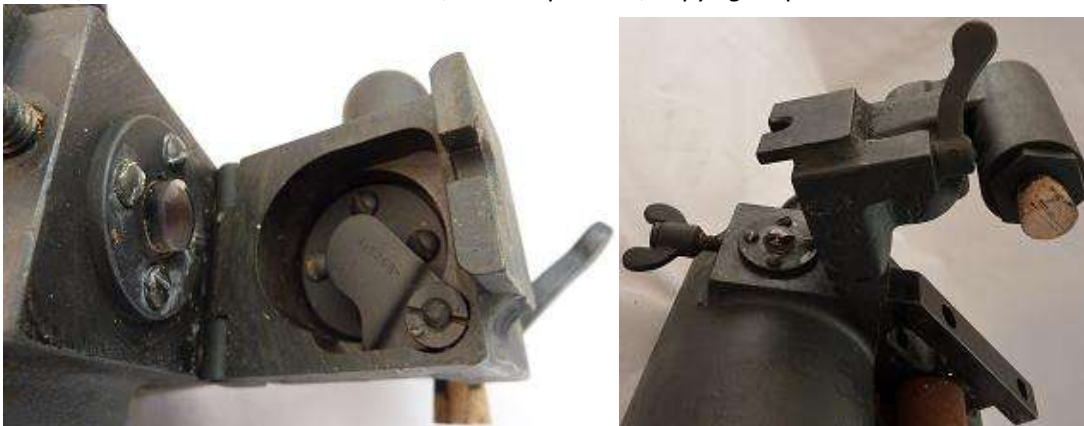

Pict 54; Bausch & Lomb MK 91 Mod 1; the lamp house opened; copyrights pictures Anna Vacani
The lamp is to illuminate the reticules (greticule – eng US) in the right ocular are crosshairs.

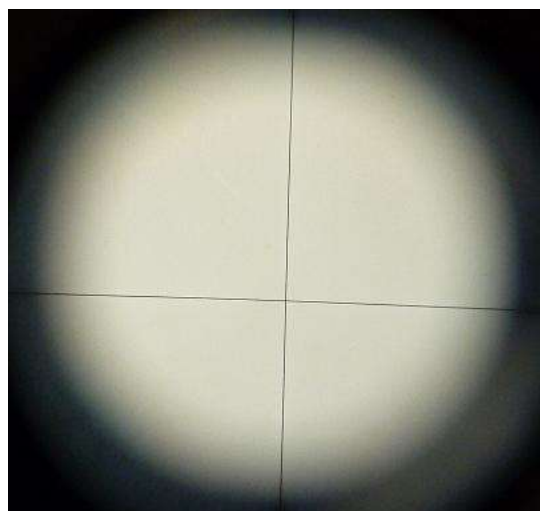

Pict 55; Bausch & Lomb MK 91 Mod 1; the reticule; copyrights pictures Anna Vacani

The eye distance adjustment is inserted between objective tubes.
The twin prism plate valves are air inlets for pressurizing the binoculars prior to descent.



Pict 56; Bausch & Lomb MK 91 Mod 1; the air inlets; copyrights pictures Anna Vacani

The outlet valves are fitted at the opposite side at the objectives.

We do not have any technical specification or technical manual of this model and it is difficult to say anything valuable about the optic of the binocular. We have not seen the binocular taken apart.

If a collector and enthusiast of this model possess the optical specification, we will be very pleased to publish it.

5. French submarine

Before the German invasion, in 1940, in French Navy were in service about 80 submarines. After capitulation the Petain's government removed the French fleet from the fight. They were partly harboured in French ports; other parts escaped to Britain or Egypt (under British control at that time) and became a part of British fleet - '**Forces navales françaises libres – FNFL**'.



French submarine – Fresnel – Laid down 7 Jul 1927. During the WWII was stationed at Oran; during the Allied landings in North Africa but escaped to Toulon. The submarine scuttled at Toulon on 27 November 1942 to prevent her capture by the Germans. Refloated on 29 January 1943; Sunk again on 19 February 1943; Refloated again on 4 May 1943; Sunk by Allied aircraft on 11 March 1944.

After the war a few German U-Boats were handed over to the French Navy by the Allies. The U-Boats were used by the French Navy up to 1960s.

6. British submarine

The main part of British Navy was escort vessels because of the need to transport all natural resources from the Far East. Among them: battleships, destroyers, cruisers for escort the convoys of transporters.

In a convoy were submarines as well “to harass the enemy convoys in places where our surface ships cannot safely go in the coastal waters of Norway, for example, or, until the conquest of North Africa, in the Sicilian narrows” – *The Navy and the Y scheme*” - published in 1944 (in our collection).

Since June 1942 the American fleet was taken part in the escort groups of merchant ships.

Among the escort groups were British midget submarines as well. Three types of midget were designed during 1941- (not purely British ideas- used in WWI); the Welman one-man submarine, the Chariot two man human torpedo and the X-craft four man midget submarine.

Those midgets had a different method of attack: the Welman attacked its target by the attachment of magnetic mines to hull of the ship; the Chariot it attacked by attaching its explosive missile mechanically to the hull of the enemy ship.

The war time actions, using the Chariot and magnetic mines are very well visible in the film - “The Silent Enemy” 1958 (it is possible to watch the film on the internet).

Six midgets X-craft had set out of Scotland and were towed across the North Sea to within range by large submarines, than taken over by four man attack crew.

X-craft were only 16 m (52 ft) long, they displaced (water) around 30 tonnes, could make 6-8 knots (11-15 km/h) underwater and they could dive to 90 m (300 ft). The two side charges, weighing about 2 tonnes apices, could be detached and planted under an enemy ship in shallow water, like in a Norwegian fiord under the German ship *Tirpitz* (September 1943). The conditions for the crew were extremely cramped.



Pict 57; British midget submarine ‘X-craft’; Picture from” The World at Arms; the Reader’s Digest Illustrated History of World War II”, page 256; in our collection



Pict 58; HMS Thunderbolt 2 – British T- class submarine – launched 29 Jun 1938, sunk 14 March 1943

During WWII other countries involved into the navy battles used their submarine vessels as well. Some as the German alliance others fought together with British [French, Polish, Norway (1 submarine), Dutch; Greek and Yugoslavian – submarines joined the British Mediterranean Fleet at Alexandria] or US.

Dutch naval forces were co-operating with British Navy around the coasts of Britain, in the Atlantic, the Mediterranean, the Pacific, and from bases in Australia.

[The binocular 7 x 50 were used on the British submarines:](#)

The British Navy was used Bar & Stroud binoculars - CF41 model 7 x 50.

We have many war time documentary films, which are showing this military model with the specific hood.

This binocular was used on the Dutch vessels serving under the British flag was model Ross 10 x 70.



Pict 59; 'Dutch sailors at action' – the picture from the book 'Queen Wilhelmina's Navy' 1944 –Issued for the Netherland Government Information Bureau; in our collection

The hand held binoculars on the British submarines were used mainly Barr & Stroud, model CF41 7 x 50. We do not have this model in our collection.



Pict 60; Barr & Stroud CF41 7x50 – with and without desiccator connections, from James Stewart collection, kindly sent for this article; Copyrights pictures James Stewart

This British binocular is unique in many ways. The exterior and interior construction is exceptional. In the most technical and illustrated way described the binocular Frank Lagorio, he writes:

CF41 7 x 50 binoculars by Frank Lagorio

“Binocular has large yellow Admiralty arrows and was the standard British naval binocular during WWII entering service in 1935 as Admiralty Pattern 1900A with continued usage into the 1970's and reportedly the Falklands War (1982).



The CF 41 was derived from the civilian CF 30 model. However, the CF 41 is considerably heavier having “watertight glands on all moving joints” (Barr & Stroud Booklet C.50) and could be filled with dry air to prevent condensation and fungus. [“this type becomes the Standard Naval Binocular and has the symbol type C.F.41” – Booklet C.60 in our collection –added by Anna Vacani] Contrary to popular belief there is no evidence that the CF 41 was ever nitrogen filled. During servicing a hand pump desiccator, a 20 kg apparatus which looked like bicycle tire pump, was attached to the desiccator connections, and the air inside the binocular was hand pumped from the binocular into the apparatus to a silica gel filled desiccator chamber which dried the air prior to its being pumped back into the binocular.



Binocular is internally fitted with selectable green, grey and yellow filters.



Has a Porro II design with prisms cemented together and the ocular field lens cemented to the prism surface to increase light transmission by reducing number of air/glass surfaces. Note desiccator tubes underneath prism.



Field of View: est. 7 deg = 123 m/1,000 m; APFOV 49 deg
Weight: 1570 gram
Exit Pupil: 7.14 mm

I have so far seen CF 41's in three movies. Not unexpectedly it appears in 'Sink the Bismarck!' (1960) and in 'The Longest Day' (1962). Most unexpectedly, Miss Marple played by Jane Rutherford can be seen wielding one in 'Murder Ahoy!' (1964)."

It was very good exposed in the film "The Silent Enemy" 1958.
All pictures were taken by Frank Lagorio; Copyrights pictures Frank Lagorio.

Additional explanation of the desiccator tubes in CF41 we can find in William Reid article "Barr & Stroud 'Nitrogen-filled Binoculars': the facts" – published in "Bulletin of Scientific Instrument Society" No 81 (2004). The author explains the method of drying interior binoculars, using a special instrument – desiccator.

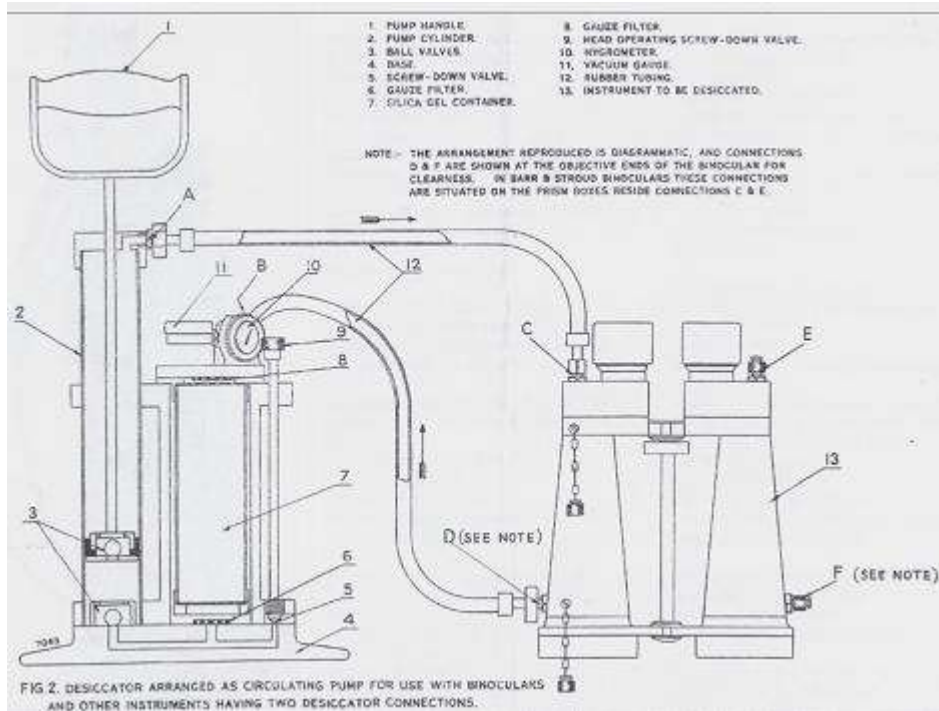

Pict 61; Desiccator – the picture inserted into William Reid article; Photo courtesy of William Reid



Fig. 3 Barr & Stroud CF41/AP1900A (WR/K017) in the process of desiccation. This binocular, serial no. 70119 was sold to the Admiralty in 1945. (Reid, note 4, op. cit., p. 172).

Pict 62; Barr & Stroud CF41 connected to the desiccator – the picture inserted into William Reid article. Photo courtesy of William Reid

The British collector and enthusiast of the Barr & Stroud James Stewart, additionally says: "Many CF41 (and 42's) also have extending anti spray hoods which consist of 26 metal strips riveted to the objectives beauty rings, these twist to extend, something uniquely British and very '1930's' by way of concept, design and construction."

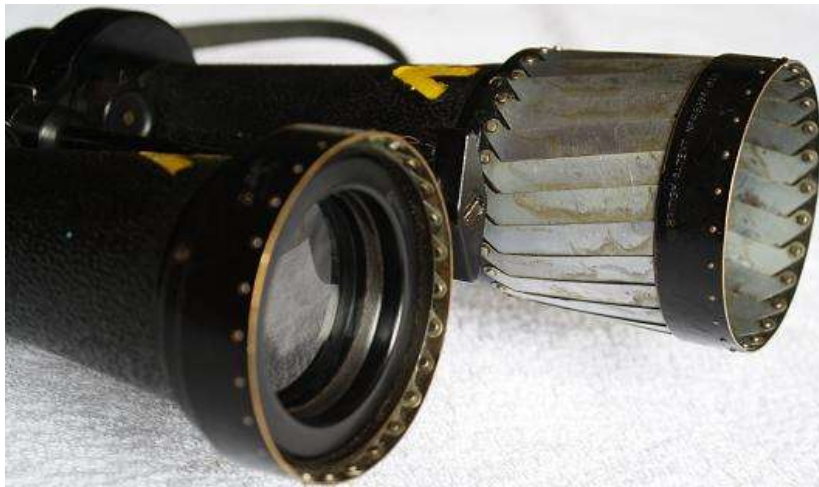

Pict 63, 64; Barr & Stroud CF41 7x50 from James Stewart collection, kindly sent for this article; Copyrights pictures James Stewart

More equipment on British ships bridges you can find at:
<http://blog.ontheslipway.com/?p=1647>

A short history of one Danish U-boat:

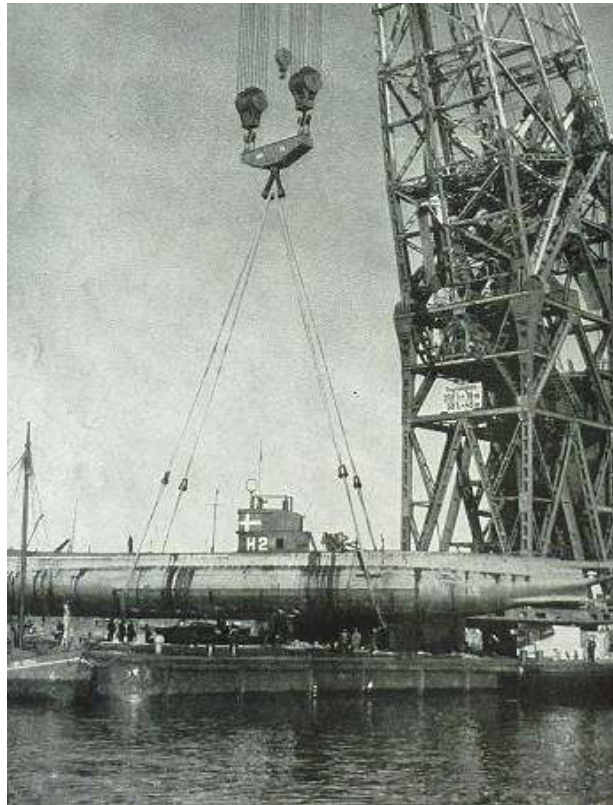

En af de sænkede Undervandsbaade hæves af Tyskerne.

Pict 65; - "One of the sunken U-boats is being salvaged by the Germans" – kindly translated by Dr Robert Forslund. The picture from the book; 'Fra Undertrykkelse til Befrielse 5 aars besaettelse i Billeder' 1945 – in our collection

Dr Robert Forslund has sent further information about the pictured U-boat: "The picture shows the Danish U-boat H2 Havfruen (The sea-maid). She was scuttled on the 29/8 1943 at 'Holmen', the navy station in Copenhagen. On that day 32 Danish navy ships were scuttled and 13 escaped to Sweden. It was to prevent them being taken over by the Germans."

The following summary published in the 'History of the Second World War' may help to visualize how the large submarine fleet was built during WWII:

	Germany	Japan	Britain	USA	USSR
	Submarines only. Few major surface vessels were built during the war.	Fiscal year	Displacement tons		Net tonnage
1940	23,800 tons	94,700	263,200	52,600 (July-Dec)	
1941	147,600	226,200	437,200	219,300	
1942	193,000	254,000	481,400	859,500	
1943	211,400	230,100	609,600	2,667,400	
1944	276,300	468,400	583,400	3,176,800	
1945	54,900 (Jan-May)	66,700 (Apr-July)	312,800 (Jan-Sept)	1,190,000 (Jan-June)	

In the technical specification of the submarines used during WWII, it is difficult to find the information or recommendations on what kind of binoculars handheld or deck mounted should be used on a submarine of any country. We can learn about them only from the documentary films or the pictures taken during the WWI or WWII.

V. U-boat glasses produced only to be used to U-Boats

Despite of the Versailles Treaty, Germany began to rearm during 1930s. Among other weapons they built up new U-boats.

The number of German U-boats which taking part in WWII may indicates the large number of required binoculars.

We can read in the book "U-Boat War" by Lothar- Gunter Buchheim (an official War correspondent for Propaganda Ministry) in the chapter "Bridge Watch" he writes: "Every watch is composed of one officer, one petty officer, and two seaman. With their powerful binoculars, they incessantly scan the horizon and the air space above...."



On the next page describing this picture he says: "Instead of the usual four-man watch, there are six men up on the bridge: it is particularly important at this point to be on guard against surprised attack"

The hand held binoculars described in chapter "*The binocular 7 x 50 used on the German U-boats*" were not robust constructed for use in a U-boat environment.

Most of them have poor sealing on body parts.

For instant *Beh* (Leitz) are very susceptible to cheap prisms because of their poor prism mounting. In view of the fact that these binoculars had to be replaced frequently due to technical problems, Carl Zeiss had begun to work over proper binoculars for using on the u-boats. They wanted to binoculars were more watertight and stable.

Carl Zeiss Jena had produced two sizes of the U-Boat glasses: 7 x 50 and 8 x 60. The models 7 x 50 and 8 x 60 were produced by Emil Busch Rathenow as well with minor internal differences. The coating was slightly deferent in addition.

At least three versions of the 7 x 50 U-boat glasses were produced.

Presumably the first model of 7 x 50 u-boat binocular was produced with:

- 23 mm eye lenses,
- flip up eyecups
- And no rubber armouring.
- The top eye lens is of two elements cemented and a single element field lens.

The second version was nearly the same design as the first one, except of the:

- Eye lens is 19 mm – assembly of the eye lenses has been changed

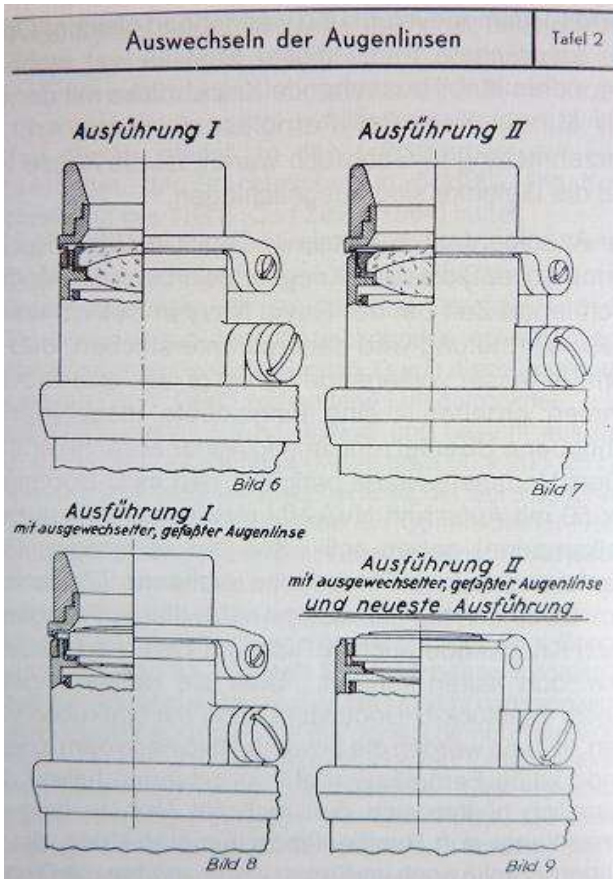

Ocular lens replacement (Model I and Model II):

Picture 6: model 1; Picture 7: model 2; Picture 8: model 1 with replaced framed ocular lens; Picture 9: model 2 with replaced framed ocular lens and latest version (kindly translated by Burckhardt Lorenz).

- Rubber armoured.



1. Bolt
2. Dioptrien scale
3. Focus knob

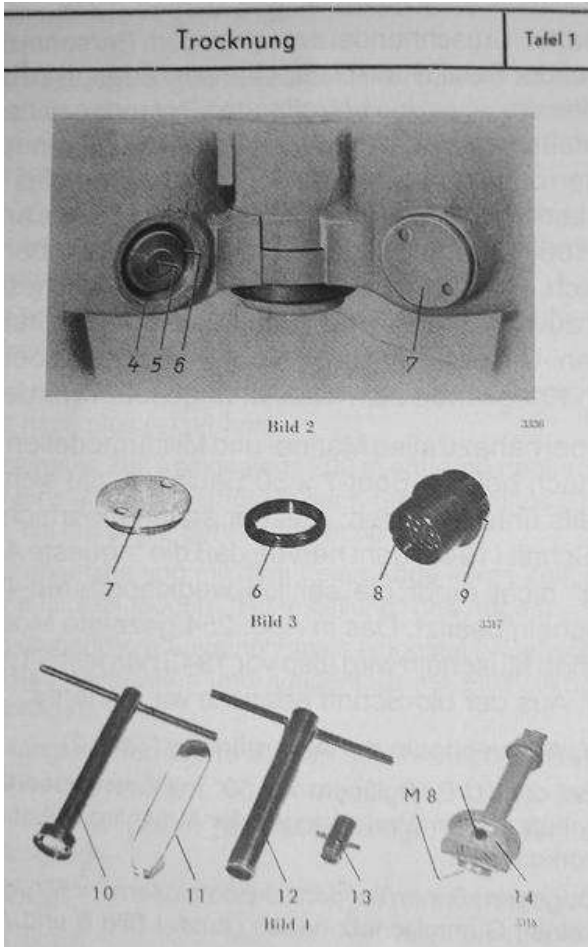

- 4. Key way
- 5. Contact pad
- 6. Locking ring
- 7. Blanking cap
- 8. Front ring
- 9. Flange
- 10. Blanking cap key
- 11. Cartridge extractor
- 12. Locking ring key
- 13. Cartridge opening key
- 14. Drying adaptor

Pict 66; The pictures are from the Dr Hans Seeger "gray" book, page 376; Photo courtesy of Dr Hans Seeger.



Pict 67; 7 x50 blc, Prod No2241074 (June 1942), 19 mm eye lenses, in our collection; Copyrights pictures Anna Vacani

The third version is fitted with:

- a single element eye lens
- And two elements cemented field lens.
- And rubber armoured.

Many first models have had:

- the eye lens arrangement converted to the second model specification;
- and had the metal eyecup flaps removed;
- And converted with rubber armoured as the second and third model.

The cxn model was produced only in the third version.

In 1940 the new design of the u-boat binoculars by Carl Zeiss was finished. The first series of the 7 x 50 u-boat glasses was produced in 1941; it was produced 1000 units of the binoculars. Some very early models were marked Carl Zeiss Jena with eagle and swastika.

1. External features of the binoculars

1. External features of the binoculars

The body was cast alloy construction; they were finished with smooth or textured green paint. The texture was made in a special way.



Pict 68; On the cut is visible the kind of metal of the body construction; Copyrights picture Anna Vacani

Presumably the texture was created with mixture of paint and sawdust and baked in the oven.

The early version, on the lower bridge hinge is fastened the rubber cord of the rain guard (Benutzer).

In the period of 1941 – 1943 the binoculars were made without rubber armoring.

The eyepieces were fitted with hinged Bakelite cups, as a flip up eyecups.



Pict 69; 7 x 50 blc from Dr Stephen Rohan collection, Prod No 2109605; Pictured by Dr S. Rohan; Copyrights: Dr Stephen Rohan

In 1943 the glasses construction were improved.
The 23 mm eye lens was exchanged for 19 mm diameter. The metal work on the eyepiece mount had to be change with some new metal parts as well.



Pict 70; The 7 x 50 U-boat binocular, prod No 63300 (finished with smooth green paint) from our collection; Copyright of the picture Anna Vacani

Later version the rubber cord is inserted into the guide on top of the upper hinge.



Pict 71; The rubber cord fitted into the guide .

Desiccators (drying) cartridges are integrated into the bottom of the prism housing on all models.



Pict 72; The 7 x 50 U-boat binocular, prod No 56718 from our collection; Copyright of the picture Anna Vacani

The original synthetic rubber gives off a characteristic smell.

Under the right top rubber prism cover is engraved "7 x 50 blc" and production number. The left side is plain.



Pict 73; the right plate - under rubber cover engraved "7 x 50 blc" and production number

It is much heavier binocular than any other 7 x 50 models used before on the vessels; it is about 1640 grams.

In February 1943 Carl Zeiss Jena produced next model of U-boat glasses – model 8 x 60. The binocular is known as: "U- Boat – Kommandantenglas" or "the fat 8 x 60".



Pict 74; Kurt Petersen the commander of U-541 pictured with 8 x 60



Pict 75; The 8 x 60 U-boat binocular, prod No 48937 from our collection; Copyright of the picture Anna Vacani

The binocular body was made from a cast alloy, as 7 x 50 models, and finished with textured yellow green paint. It is slightly different construction of the body than the first model of 7 x 50. At first sight it seems the same, only larger.



Pict 76; The 8 x 60; 7 x 50 first model; 7x 50 third model U-boat binoculars

The hinge is incorporated into the bottom of the prism house and ties the objectives rings. The rubber cord is fitted into the small separate clip incorporated into extended top main hinge.



Pict 77; The rubber cord of 8 x 60 U-boat binocular, prod No 48937 from our collection; Copyright of the picture Anna Vacani

The desiccated cartridges are in the same place as in 7 x 50 models. The 8 x 60 model normally was not rubber armoured, but we have seen a rubber armoured version. The eye lenses are constructed in similar way as 7 x 50 models. The eyepieces are fitted with hinged black Bakelite cups. The flip up cups allow using the binocular wearing sunglasses or to aid in cleaning eye lenses.



Pict 78; The Bakelite eyecup of the 8 x 60 U-boat binocular, prod No 211188 from our collection; Copyright of the picture Anna Vacani

As the binocular was rather heavy – 2552 grams it was made with two versions of a tripod adapter. We have both the versions.



Pict 79; The short adapter for 8 x 60 (to Deck Mounted as well)



Pict 80; The long adapter (named 'Swan') - for 8 x 60 binoculars in our collection

On the top of the 'Swan' adapter's base is the container for the lubricating oil. The bolt is engraved with word 'Öl'.



Pict 81; The oil compartment and the bolt

The lubrication of the base was important in such humid and dump environment, where the adapters were used.



Pict 82; 8 x 60 b/c Prod No 48937 with the short mount, in our collection; Copyrights Anna Vacani



Pict 83; 8 x 60 b/c Prod No 211188 with the long adapter, in our collection; Copyrights Anna Vacani



Pict 84; 8 x 60 b/c Prod No: 211188 & 48937 with the adapters, in our collection; Copyrights Anna Vacani

The mounts have their own embossed numbers that correlate (matched) with the numbers on binoculars bottom arm bending bar.

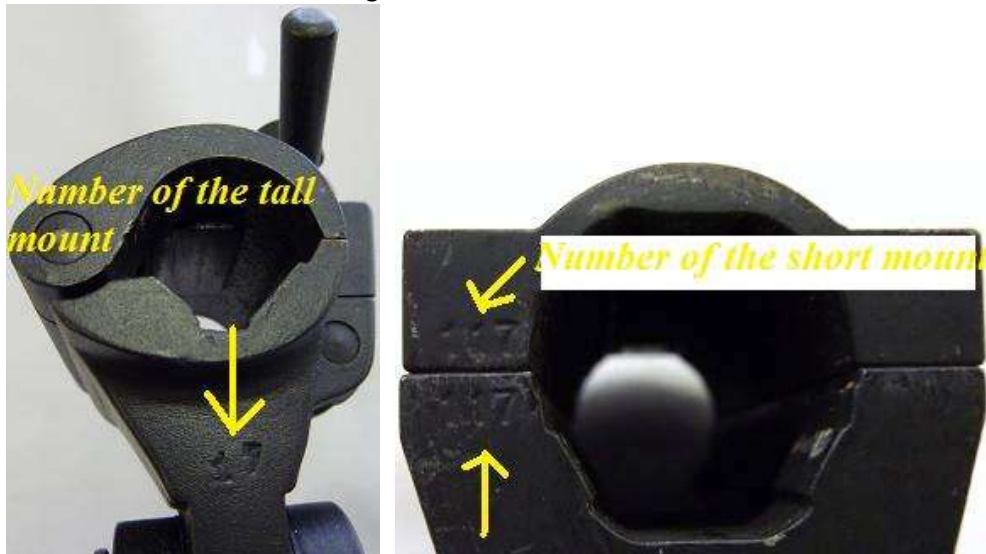

Pict 85; The adapter's numbers



Pict 86; The number on the 8 x 60 Prod No 211188

The binoculars were supplied by Carl Zeiss Jena in three different transport boxes;

- One is constructed for one binocular with a small adapter;



Pict 87; 8 x 60 in the original blc box; Copyrights pictures Terry Vacani

- Next box contains binocular, filters and large adapter and sunshades.

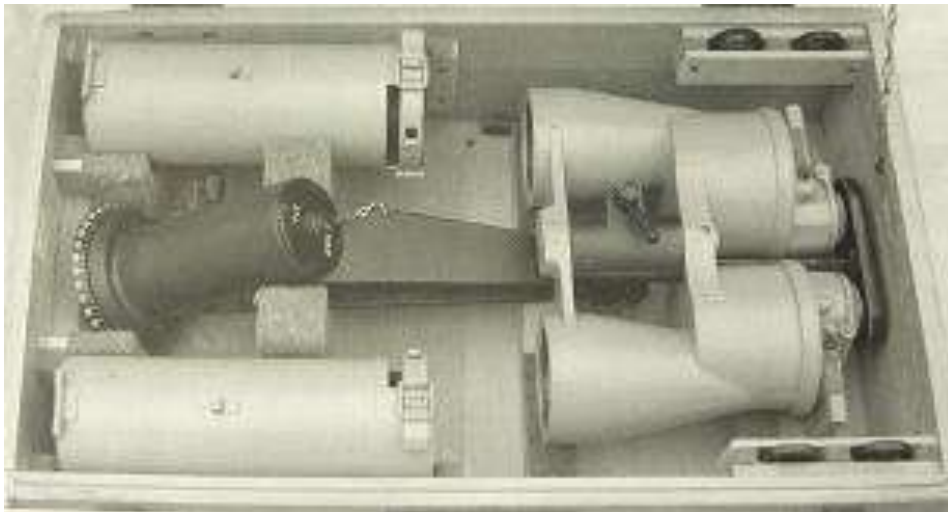

Pict 88; The picture is from the Dr Hans Seeger "grey" book, page 384; Photo courtesy of Dr Hans Seeger.

- The biggest box holds five pair of 7 x 50 binoculars without mounts.



Pict 89; Five pairs of 8 x 60 U-boat binoculars in original box; Picture courtesy of Frank Doherty

However, the 8 x 60 Carl Zeiss binocular produced on a Swedish contract has a different box internal lay out, as Dr Robert Forslund is showing in his book – "Swedish Military Binoculars" – page 39.

The binocular could be mounted into UZO (U-Boot-Zieloptik = U-Boat aiming optic) of the vessel with a special adapter fitted for 8 x 60. The hinge of 8 x 60 is thicker than the U.D.F 7 x 50 binocular.



Pict 90; 8 x 60 fat model and U.D.F. 7 x 50 from our collection; Copyrights picture Anna Vacani

Both models 7 x 50 and 8 x 60 are fitted with the Bakelite Benutzer rain cover.



Pict 91; The rain cover of the 7 x 50 U-boat binocular, prod No 56718 from our collection with the engraved the word 'Kommandeur' (it is not proved that it was engraved by a U-Boat Commander); Copyright of the picture Anna Vacani

At the end of this chapter we have to pointed out that there never was produced a leather case for 7 x 50 and 8 x 60 fat model u-boat glasses.

Next, the 7 x 50 and 8 x 60 were never produced with black paint finish. Some collectors' strongly believe that it was a 'black model'. It is possible to prove that this idea is a wrong supposition. Disassembling the complete binocular it is always possible to find some original green paint under the bottom hinge tension screw unit, the top plates covering the prism house, around hinges. It is visible on the picture of our half 7 x 50 blc, the binocular was painted two times, but original paint is under the rim of the top plate.



Pict 92; Half 7 x 50 blc in our collection, production No 63954;

2. Internal features of the binoculars – optic system

The optic system of the 7 x 50 and 8 x 60 is Porro I.

7 x 50 - Pupil exit 7, 1 mm; adjustment of the pupil distance - from 51 to 74 mm; weight 1, 5 kg. Eyepiece adjustment features are only possible with a special key.

The optical light transmission of the first and the second model is superior to the third model; Because of the thickness of the glass elements in the eye lens construction. The third model has much thicker glass than model one and two.

The first, second and third model are not coated on the outside surfaces of the glass. However, all internal surfaces are coated.

Exception to this statement is that some blc models produced in 1944 have multicoated lenses, reddish purple colour, which is also coated on the outside of the objectives and eye lenses.



Pict 93; 7 x 50 blc multicoated, production number 62720, from Peter Lamb collection; Pictures taken by Anna Vacani

After that time CZJ went back to the normal coating.
This multicoated model is very good if the outside objectives and eye lenses are not badly scratched with the coating damaged.
The prisms of all models and the objectives are all the same specification.
We have discovered in our collection two half 7 x 50 blc binoculars.



Pict 94; 7 x 50 U-boat, with the optic visible, production No 63954 taken apart from our collection; Copyrights of the picture Anna Vacani



Pict 95; 7 x 50 u-boat prism from our collection; Copyrights of the picture Anna Vacani



Pict 96; 7 x 50 U-boat - the cover plate with the rubber seal, from our collection; Copyrights of the picture Anna Vacani



Pict 97; 8 x 60 u-boat prism fitted in the body and prism in the prism shelter ; Copyrights of the picture Anna Vacani

U-boat binoculars are semi fixed focus on the following models:

- 7 x 50 blc and cxn rubber armored U- boat glass models.
- 8x 60 fat model blc and cxn.

These models can be adjusted focus from the top of prism housing with screwdriver, according to the sight of the user.

Some of the 8 x 60 has a vertical line reticule fitted in right hand ocular. The 7 x 50 models never had fitted graticule.

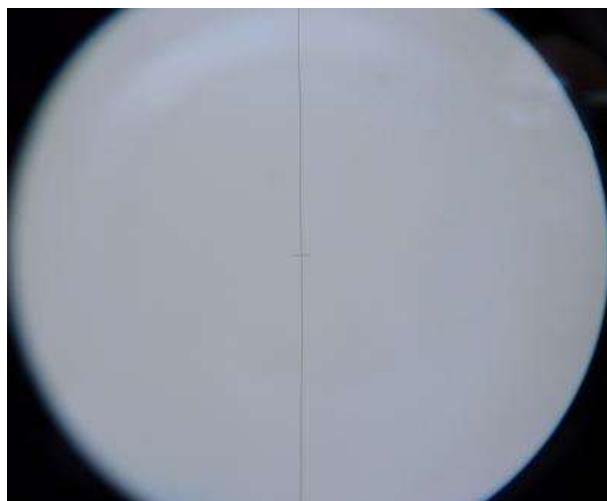

Pict 98; The graticule in the 8 x 60 U-boat binocular, prod No 48937 from our collection; Copyrights of the picture Anna Vacani



Picture from- 'U-Boot-Fahrer '(U-Boat Sailors) by Lothar-Günther Buchheim; published by Piper 2001; ISBN 3-492-04044-6; page 286-287;The picture was kindly found and sent by James Stewart; the book is in his collection. The photo, the bridge crew - U-309, at the time they had picked up survivors from U-981, this boat had been sunk by a Halifax of Coastal on 12th August 1944.



Picture from- 'U-Boot War' (translation of U-Boat- Krieg) by Lothar-Günther Buchheim our collection, published in 1978 by William Collins Sons& Co .Ltd in London; the author described the picture: "...these of the bridge watch ... are not permitted even a glance toward the rescue..."

The date of the picture, taken by-Günther Buchheim – an Official Naval correspondent on German U-boat U-96, suggested that in August 1944 the 7 x 50 u-boat glasses were used on German U-Boats.

After the war the owner of the U-Boat glasses tried to make them useful in many ways. It is one example – cutting in halves and making a monocular.

In the UK, in shops catalogue- “Headquarter and General Supply Limited” c.1955, the 7 x 50 U-boat binoculars were listed for sale and priced for £ 37. They were the only war time binoculars which were sold very quickly.

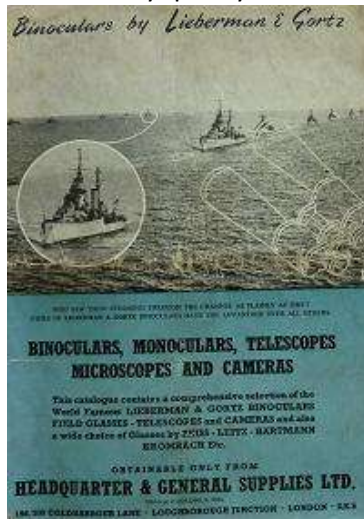

Pict 99; The 7 x 50 u-boat binocular in the Catalogue “Headquarter and General Supply Limited” c.1955, in our collection; Copyrights of the picture Anna Vacani

3. Swedish version of the U-boats binoculars

The U-boat binoculars 7 x 50 and 8 x 60 were sold to Sweden.

Dr Robert Forslund writes: “In 1944 the KMF [The Swedish Admiralty] was offered a CZJ 8 x 60 binocular to use as observation binocular. [...] it was decided to buy 10 sets at a price of 1.250:- RM each. The binoculars were offered in a wooden box with extras”



Pict 100; 8 x 60 blc from Dr Robert Forslund collection; Pictured by Dr R. Forslund; Copyrights Dr Robert Forslund

This model is unusual because on the left plate is Carl Zeiss Jena logo and production number - 371074. On the right plate is a Swedish number and production year – 1944.



Pict 101, 102; 8 x 60 Carl Zeiss Jena from Dr Robert Forslund collection; Pictured by Dr R. Forslund; Copyrights Dr Robert Forslund



Pict 103; 8 x 60 blc from Dr Robert Forslund collection, Prod No 48928; Pictured by Dr R. Forslund; Copyrights Dr Robert Forslund

The binoculars were given a Swedish number and three crowns on the left plate.



Pict 104; 8 x 60 blc from Dr Robert Forslund collection, the left plate; Pictured by Dr R. Forslund; Copyrights Dr Robert Forslund

The Swedish Navy had bought 8 x 60 made by Busch (cxn) as well. Binoculars were marked in the same way as those bought from CZJ.



Pict 105; 8 x 60 cxn from Dr Robert Forslund collection, Prod No 425522; Pictured by Dr R. Forslund; Copyrights Dr Robert Forslund



Pict 106; 7 x 50 blc (first model) from Dr Robert Forslund collection, Prod No 105456 (?); Pictured by Dr R. Forslund; Copyrights Dr Robert Forslund



Pict 107; 7 x 50 blc (third model), coated, from Dr Robert Forslund collection; Pictured by Dr R. Forslund; Copyrights Dr Robert Forslund

Both 7 x 50 blc models were given a Swedish numbers and three crowns on the left plate.

[VI. Varieties of U-Boat glasses produced in other countries](#)

We would like to describe two binoculars similar in design to the binoculars used in WWII on German U-boats vessels – produced in Russia and Canada.

1. The Canadian binocular

The Canadian binocular 7 x 50 model has caused many controversies among collectors. Opinion was divided, whether it is a u-boat binocular or not.

[Frank Lagorio kindly has sent us a short history of this model:](#)

“Research Enterprises Limited (REL) was established in 1940 as a crown company by the Canadian government. REL began production of optical glass in 1941, and by the end of WW II had produced approximately 60,000 6X30 binoculars and 30,000 7X50 binoculars. The REL 7X50 binoculars are similar in appearance and build to the U.S. Navy Bu Ships Mk. 1. and Army M7 excepting the dry air ports on most REL's. REL manufactured three types of 7X50 binoculars: the CGB 54 GA, CGB 57 GA and CGB 40 MA.

The meaning of the CGB prefix is unknown. Research indicates it does not, as often reported, mean Contract Great Britain. The GA (General Arrangement) and MA (Master Arrangement) designations respectively indicate the binocular was issued with or without a case, but frequent British and American usage of these terms referencing an optical instrument's design drawing suggests they may have additional significance.

REL's first 7X50 binocular was the CGB 54. It was made in 1942 in low numbers - probably less than 1,000 - and is externally distinguished from other REL 7X50's by having no dry air ports and three prism plate screws.

The CGB 57 was the second type produced, about 9,000 being made from 1942-1944, and usually having three prism plate screws with two dry air ports on each prism plate plus a third port behind each objective barrel.



REL's third type was the CGB 40 MA. It was made in the highest numbers, serial number studies indicating production of about 20,000. They were made 1944-1945 and are distinguished by having a single dry air port on each prism plate plus one behind each objective barrel and having four screws per prism plate to improve sealing.

During the early 1950's and possibly as early as WW II some CGB 57's were modified by the Beacons Optical Products Company of Quebec (BOP) with carousel filter assemblies in the rear prism covers. Although there is no photographic or written evidence that these binoculars were used during WW II, the fact that the CGB 57 was chosen for conversion instead of the later and better sealed CGB 40 suggests development occurred early in the war before the CGB 40 was available. Further, the presence of British Admiralty arrows on the barrels of some examples may indicate WW II use. There is no doubt, though, that conversions were made during the 1950's because of the existence of boxed modification kits manufactured by BOP which are dated 1953. The number of BOP converted REL's appears low – probably only several thousand were made. Most certainly

because of their type of filter system (to say nothing of weight) they were intended solely for naval use.

The BOP conversion entailed: 1) Addition of a large prism plate on each barrel housing a carousel type filter with four settings - clear (O), yellow (Y), grey (G), and dark grey (D). 2) Addition of anti-reflection coated optics (the great majority standard CGB 57's did not have coated optics). 3) Because the new prism plates were thicker than the original ones, objective cell housings and decorator caps were changed to accommodate focal length requirements resulting in a binocular which is about 3 mm shorter than a CGB 57.

Specifications

Manufacturer/Model: REL C.G.B. 57 G.A. 7X50 with BOP Filter Modification

Field of View: 7.16 deg = 125 m/1,000 m; APFOV 50.1 deg

Weight: 1792 gram

Exit Pupil: 7.14 mm

Note: The above descriptions of REL 7X50 binocular types are according to the most prevalent examples which are mostly in the middle serial number range. There are many variations. For example: low serial numbered CGB 57's may not have any dry air ports and high numbered ones may have four screws per prism plate instead of the usual three; a small number of high serial numbered CGB 57's had coated optics and were marked "Flourided" (probably a later modification); many low serial numbered CGB 40's had two dry air ports per prism plate instead of the usual one; one BOP modified 7X50 has been seen with a CGB 40 marking affixed over an apparent CGB 57 marking. "

All pictures were taken by Frank Lagorio; Copyrights pictures Frank Lagorio.

After the war the binoculars used on the submarines vessels were produced in other countries as well. Many features are the same as in those produced before and after the WWII.

2. The Russian binocular

The Russian binocular BM 7 x 50 is in our collection. It was produced in 1969; Production number 699447. The first two digits of the production number indicate the year of manufacturing.

The binoculars' description is only on the left plate in Russian language.



Pict 108; BM 7 x 50 Russian submarine binocular; Copyrights of the picture Anna Vacani

The binocular body is made from a cast alloy and covered with a black synthetic leather material. Similar to the German binocular is rubber armoured with a soft rubber.



Pict 109; BM 7 x 50 Russian submarine binocular, one side of the binocular without the rubber; Copyrights of the picture Anna Vacani

The optics arrangement is Porro I and it is coated. The focusing mechanism is fitted under the top rubbers as an adjustment knob. A user can easily adjust focus to his individual eye sight.



Pict 110; BM 7 x 50 Russian, the binoculars' description on the left plate and the focus adjustment; Copyrights of the picture Anna Vacani

Drying cartridges divisions are integrated into the bottom of the prism housing, in the same place as the German u-boat models.



Pict 111; BM 7 x 50 Russian submarine binocular; Copyrights of the picture Anna Vacani

The compartments are fitted with silica gel patrons. On the binocular box cover is placed the instruction on how to replace worn silicone dryers. The manual says that when the cartridges vary from gray colour to white-pink, the cartridges must be changed. The colour changed is visible through the small windows installed in the cartridges top lock.

A tiny pouch on the cover holds two tiny containers with the additional silicone drying cartridges.



Pict 112; BM 7 x 50 Russian submarine binocular with the original case and accessories; Copyrights of the picture Anna Vacani

Four filters are supplied: two in gray grey and two in orange.

The weakness is that eye lens design and diameter is of a different construction than the original blc models.
In the left ocular is fitted the graticule.

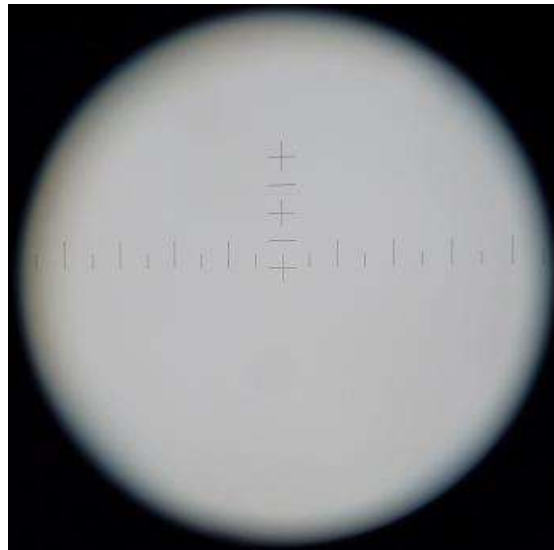

Pict 113; The graticule in the left side Russian 7 x 50 BM model; Copyrights of the picture Anna Vacani

The performance of the binocular is good but not as good as the blc models.

[VII. Appendix](#)

All enthusiasts of the submarines can visit converted U-Boats in Germany, as we had visited one – Wilhelm Bauer in Germany, Bremerhaven.

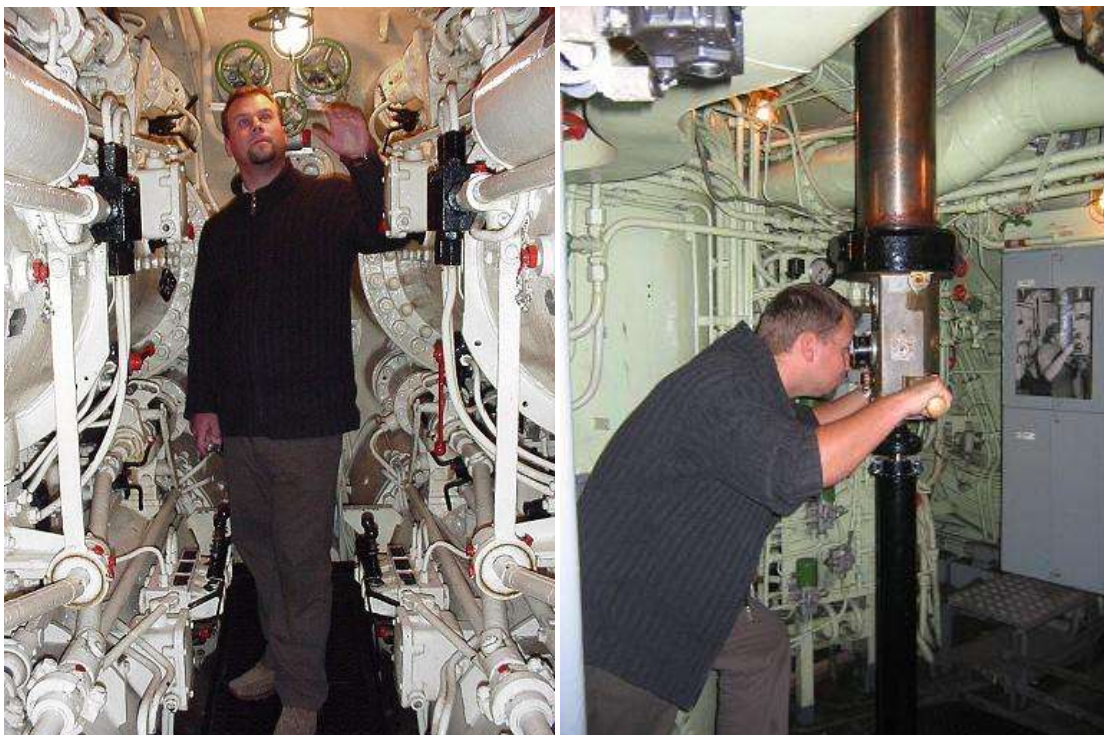



[http://en.wikipedia.org/wiki/Wilhelm_Bauer_\(U-boat\)](http://en.wikipedia.org/wiki/Wilhelm_Bauer_(U-boat)) Bremerhaven

In the USA are 25 submarines converted into Museum. Here is a link kindly sent by Olga Brodowski from Virginia Beach: <http://www.submarinemuseums.org/>

We hope this article lets all enthusiasts better understand this huge issue of the submarines in WWII.

Bibliography:

The part about submarines details has been written on the book;

1. *U-Boats Intelligence 1914-1918*, by Robert M. Grant; Published in 1969 by Putnam London; in our collection;
2. *The World at Arms; the Reader's Digest Illustrated History of World War II*; Published by Reader's Digest Association Ltd; 1989
3. *The U-Boats; The Seafarers*; by Douglas Botting and the editors of Time-Life books; Published in 1979 Amsterdam; as the second European English language printing in 1983; in our collection;
4. *U-Boat, One of the deadliest Weapons of the war*; History of the Second World War Magazine Volume 7 Number 9; Published in 1968 by Purnell & Sons Ltd; in our collection;
5. *Wolfpack, U-Boats at War 1939-1945* by Philip Kaplan and Jack Currie; Published in 1999 by the naval Institute Press, Annapolis, Maryland (our edition); originally published in 1997 in London;
6. *The World War II Album, edited by Ross Burns*; Published in 1991 by Warfare, London; in our collection;
7. *U-Boats in the Atlantic, World War 2 Photo Album Number 11*, by Paul Beaver ; Published in 1979 by Patrick Stephen , Cambridge; in our collection;
8. *German Destroyers and Escorts, World War 2 Photo Album Number 20*, published in 1981 by Patrick Stephen, Cambridge; in our collection;
9. *U-Boats Type VII* by Robert C. Stern; Published in 1991 by Arms and Armour Press, London; in our collection;
10. *The Navy and the Y scheme*; published in 1944 for The Admiralty London: His Majesty's Stationary Office; in our collection;
11. *Queen Wilhelmina's Navy*; Published in 1944, His Majesty's Stationary Office, London; Issued for the Netherland Government Information Bureau; in our collection;
12. *After the Battle, Number 55; " U-Boat Bases", Edited by Winston G. Ramsey*; Published in 1987 by Battle of Britain Prints International Ltd, London; in our collection;
13. *Militaria Magazine No 22; December 1995*; in our collection;
14. *"Z 13" Von Kiel bis Narvik, Kriegserleben einer Zerstörerbesatzung ("Crew from the keel to Narvik, war experience of a destroyer" – translated by Google)* by *Von Kapitänleutnant (Ing.) August Wilhelm Heye*; Published by Mittler & Sohn in 1941, Berlin; in our collection;
15. Dr. Stephen Rohan – *A Guide to Handheld Military Binoculars 1894-1945. Published by Optical Press Bradbury, California, 2001 (ISBN 0-9709003-0-9)*
16. Robert Forslund – *Swedish Military Binoculars. The Best Possible Binoculars. Leezen 2009*
17. Dr Hans T. Seeger - *Militärische Ferngläser und Fernrohre in Heer, Luftwaffe und Marine; Military Binoculars and Telescope for Land, Air and Sea Service; Germany, Hamburg 1995; ISBN 3-00-000457-2*
18. Lothar-Gunter Buchheim – *U-Boat War; (Translation from original 'U-Boot – Krieg')* Published by William Collins Sons & Co. Ltd; 1978; ISBN 0 00 211868 9